

Planetgear™ 7000 Speed Reducers | Proven, Reliable, Rugged



Planetgear™ Speed Reducers

Planetgear 7000 Speed Reducer

Since 1981, the benefits of our self-aligning planetary gear train have been proven in application after application.

- Planetgear performance has withstood many tough environments, including shock loads, frequent reversals and hostile atmospheres containing moisture and abrasives.
- The new Planetgear 7000 integrates enhanced mechanical geometry with refined material processes, resulting in torsional increases of 15% to 50%.
- New Planetgear 7000 sizes are backward interchangeable for maximum adaptability and reduced changeover expense.
- Planetgear 7000 now offers a total of 14

sizes including the newly designed sizes: NeptunePlus, OrionPlus, SaturnPlus, TitanPlus, and JupiterPlus.

- There are two new sizes, Luna (same footprint as Atlas) and Delta (same footprint as Polaris), that provide additional torque intervals to suit your application needs.

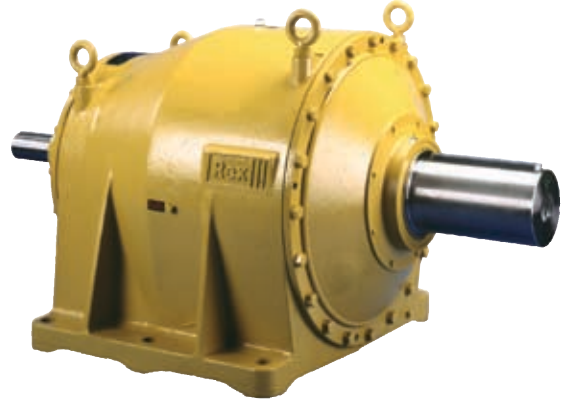

Planetgear 7000 Ratings

Reducer Series	Mercury	Mars	Venus	Atlas	Luna	Earth	Polaris	Delta	Neptune	Neptune Plus	Orion Plus	Saturn Plus	Titan Plus	Jupiter Plus
	7200	7220	7240	7260	7280	7300	7320	7340	7360	7380	7400	7420	7440	7460
Torque (lb-in)	8,000	18,000	24,000	43,000	51,000	76,000	120,000	154,000	160,000	238,000	316,000	450,000	643,000	905,000

Shaft Mounted Planetgear

- Torque capacities to 3,000,000 lb-in are available.
- Unique Hydro-Advantage hydraulic removal system. Hydraulic fluid is pumped behind the shaft applying a separating force to the reducer allowing for easy removal under the toughest environmental conditions.



Planetgear SMP Ratings

Series	Orion	Titan	Jupiter	Gemini	Hercules
Torque (lb-in)	280,000	480,000	830,000	1,760,000	3,000,000

Features and Benefits

Fast Delivery

All parts in stock. Only an assembly operation is required, thus 48 hour delivery is available.

Reliable Operation

Self-aligning planet carrier floats radially and axially to provide perfect alignment of drive train. At least six teeth share the load at each reduction to distribute the load.

Simplified Installation

Output and input shafts rotate in the same direction regardless of the number of reductions.

Durable, Rugged

State-of-the-art heat treating techniques provide hardened, wear-resistant gearing. Self-aligning gear train insures equal load distribution among the planet gears. Spline

connection between input/output shafts and gearing isolates gears from external forces.

Double Seal Protection

Taconite duty-rated seal design is standard. Two seals on each shaft provide a grease purgeable cavity to keep out dirt and moisture.

Extended Bearing Life

Tapered roller bearings on both input and output shafts provide high overhung and thrust load capacity. Shaft bearings are subject to external forces only — not internally generated gear forces.

Efficient

Efficiency in excess of 97.5% per reduction provides energy saving operations.

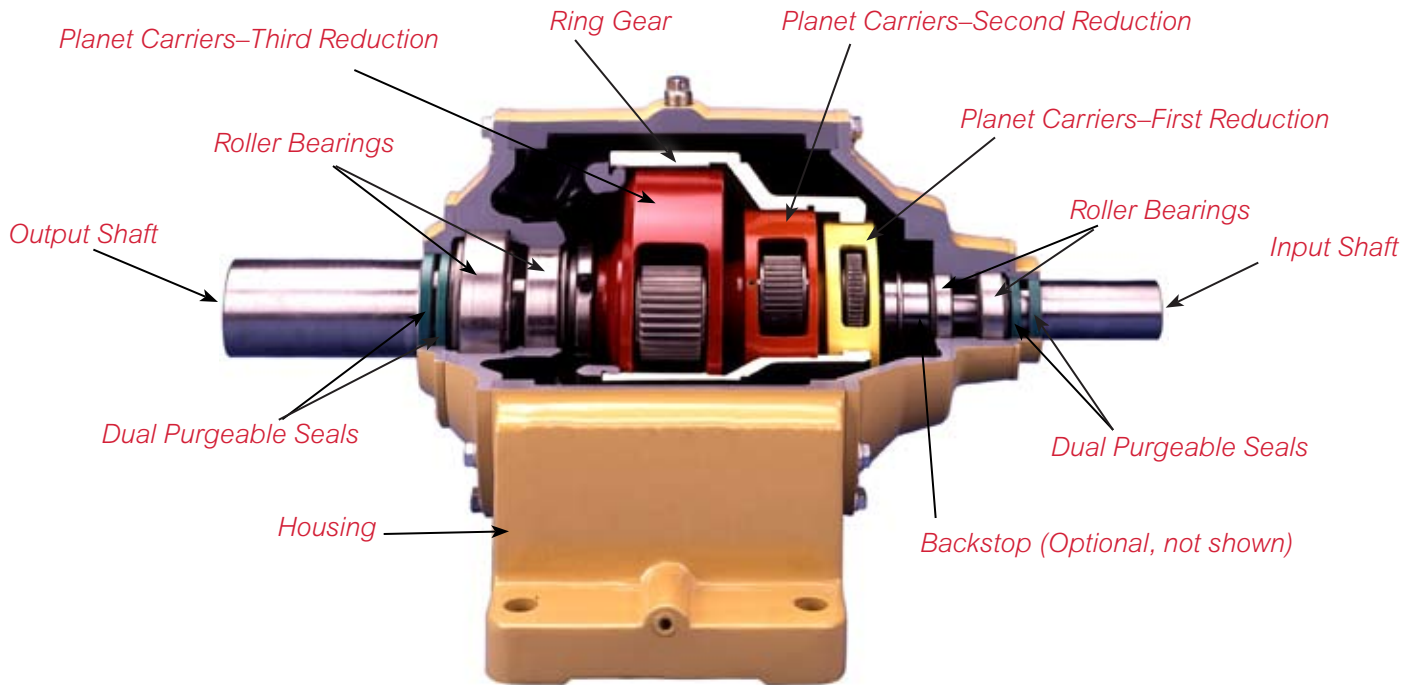

Easy to Service

No special tools required to assemble or disassemble. No shims required to set the bearing clearances.

Saves Time

Lightweight. Safe, easy mounting and handling is achieved with up to 50% weight reduction when compared to conventional drive units.

Application Flexibility

Complete line of accessories are available to accommodate any application. Even vertical service is available with only slight modifications to units.

Fast, Easy Ratio Changes

The drive consists of standardized sub-assemblies which allow fast gear ratio changes in the field: Ratios can quickly be changed since there are no internal walls to work around, and no bearing adjustments are required.

Features and Benefits

Proven, Reliable Gear Performance

With Planetgear™ 7000 reducers, self-aligning planet carriers float radially and axially to provide perfect alignment of the gear train.

Unlike “traditional gears” which have only one point of contact per reduction, Planetgear 7000 transmits the torque through three points of contact between sun gears and planet gears. The floating gear train ensures equal loading among the three points.

State of the art heat-treating techniques provide hardened, wear-resistant gearing.

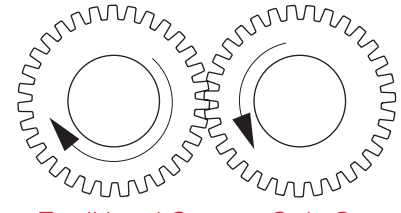

Traditional Gears – Only One Point of Contact

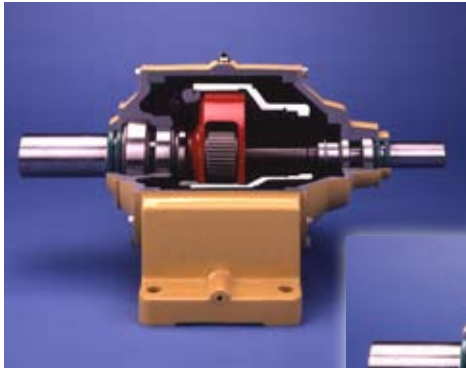

Single Reduction



Double Reduction

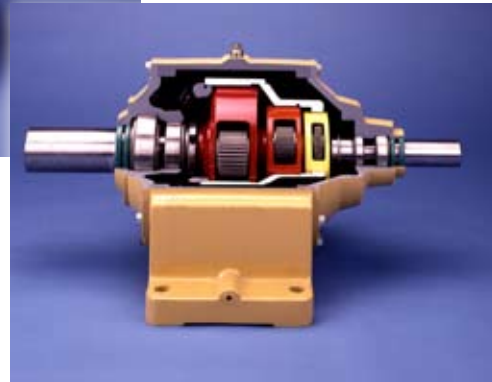

Triple Reduction



Reduction of inventory

Planetgear reducers allow user to reduce in-plant inventory. No longer do you have to stock complete reducers for each critical application in your plant. With Planetgear's unique modular design, only a handful of gears may be required. Consider the following three Earth examples.

Why stock three spares – simply stock the triple reduction and the two input gears and any of the ratios can be build in minutes.

Features and Benefits

Superior Seal Protection

How many reducer failures are attributed to bearing contamination?

Planetgear 7000 reducers are designed with TWO seals on both the input and output shafts. Our successful seal layout can be seen in the schematic shown below.

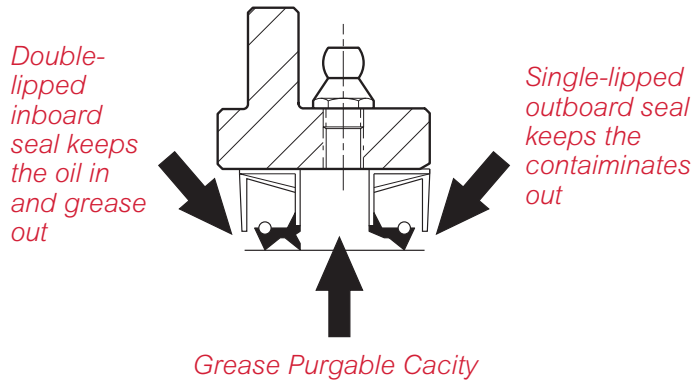

SMP Hydraulic Removal System (Hydro-Advantage)

Planetgear SMP has a unique “Hydro-Advantage” removal feature that allows worry-free removal in the harshest conditions. Hydraulic fluid is channeled behind the driven shaft generating a large separating force allowing easy separation from the reducer.

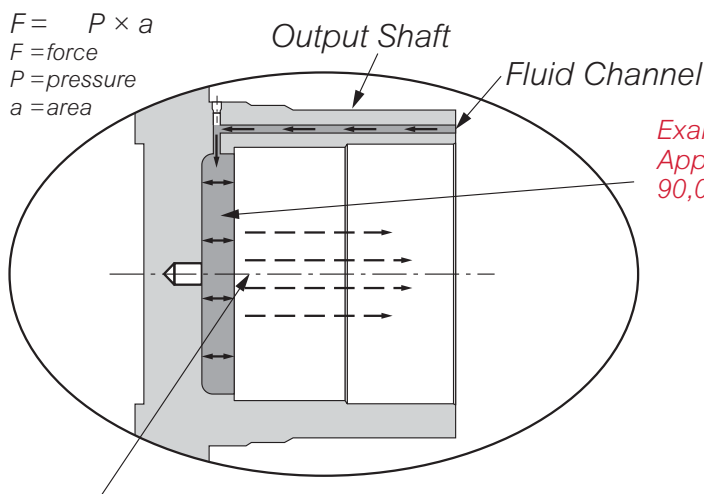

*Example
 Applying 4,500 psi to the Titan shaft generates 90,000 pounds of separating force.*

Fluid is pumped behind the shaft filling this section. The force is at the best possible location – between driven shaft and reducer shaft.

Accessories & Application Photos

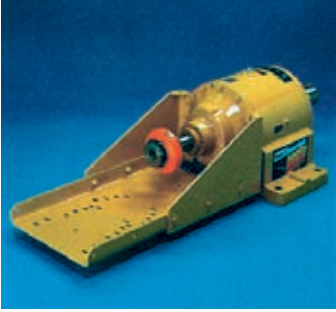

Scoop Mounts



Fans and Shrouds



Top Motor Mounts



Vertical Mounting



C-Flange Motor Mounts

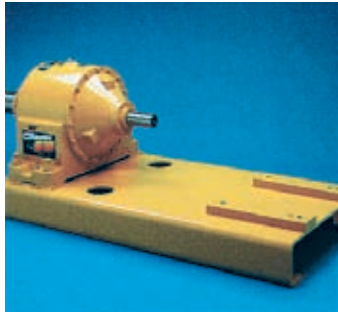

Baseplates

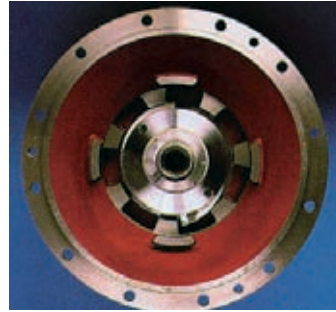

Backstops



*Torque Arms
Belt Guards*



AirMax Breathers



Dimensions – Inches

Planetgear 7000 – Single, Double, & Triple Reductions

Mercury & Mars

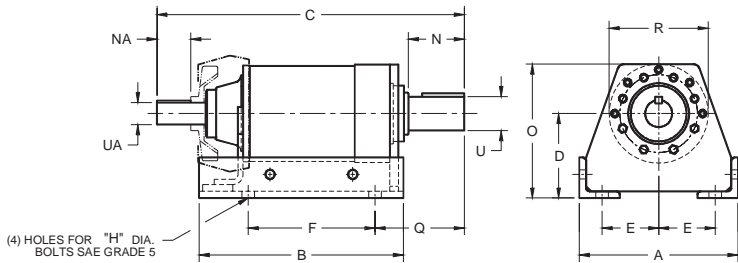

Other Sizes

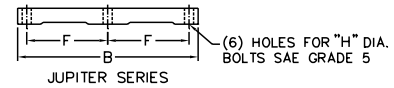
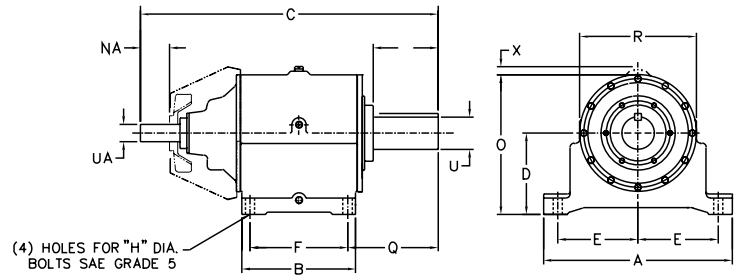

Series	A	B	C*		D	E	F	H	O	Q	Low Speed Shaft		High Speed Shaft			Avg Wt (lb)
			s, d	t							N	U	NA		UA	
													w/o Fan	w/ Fan		
Mercury	11.75	15.13	19.88	22.13	6.25	4.19	9.41	7/8	9.91	6.59	4.15	2.00	3.00	1.88	1.38	144
Mars	11.75	15.13	21.25	23.50	6.25	4.19	9.41	7/8	9.91	7.46	4.98	2.50	3.50	2.38	1.63	150
Venus	18.00	11.75	29.73	29.73	7.75	8.00	9.53	1	13.50	8.63	5.50	2.75	4.25	2.88	1.88	295
Atlas	18.00	11.75	30.73	30.73	7.75	8.00	9.53	1	13.50	9.63	6.50	3.25	4.25	2.88	1.88	325
Luna	18.00	11.75	30.73	30.73	7.75	8.00	9.53	1	13.50	9.63	6.50	3.25	4.25	2.88	1.88	325
Earth	23.25	11.75	34.08	34.08	8.75	9.88	9.53	1	15.94	11.38	7.00	3.50	4.50	3.25	2.13	481
Polaris	23.25	14.00	36.30	36.30	10.00	9.88	11.75	1	17.19	11.29	8.00	4.00	4.50	2.88	2.13	702
Delta	23.25	14.00	36.30	36.30	10.00	9.88	11.75	1	17.19	11.29	8.00	4.00	4.50	2.88	2.13	702
Neptune	29.25	11.69	42.80	42.80	11.25	12.88	8.19	1 1/4	20.94	18.83	9.00	4.50	5.68	3.56	2.50	923
Neptune Plus	29.25	11.69	42.80	42.80	11.25	12.88	8.19	1 1/4	20.94	18.83	9.00	4.50	5.68	3.56	2.50	923
Orion Plus	29.25	19.62	46.21	46.21	11.25	12.88	16.00	1 1/4	20.94	14.37	10.00	5.00	5.68	3.56	2.50	1146
Saturn Plus	33.25	19.86	51.78	51.78	12.88	14.63	11.00	1 1/2	24.25	22.04	11.25	6.50	6.50	4.38	3.00	2000
Titan Plus	33.25	19.86	51.78	51.78	12.88	14.63	16.00	1 1/2	24.25	18.74	11.25	6.50	6.50	4.38	3.00	2000
Jupiter Plus	33.25	28.88	62.94	62.94	16.50	14.63	12.50†	1 1/2	31.50	20.88	12.25	7.25	6.50	4.38	3.00	3470

* For Mercury and Mars with backstop add 0.66".

Planetgear SMP

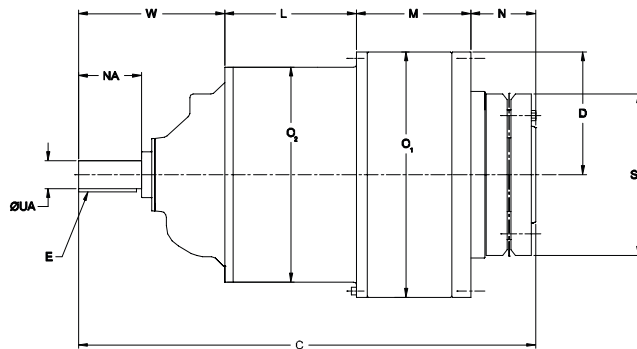

Series	Output Torque (lb-in)	Hollow Shaft Bore	C	D	L	M	N	O ₁	O ₂	SD	W	Input Shaft Detail			Weight
												UA	NA	E-Key	
Orion	280,000	5.44	33.36	9.19	8.70	8.63	4.65	18.38	14.37	11.81	11.45	2.125	4.50	1/2 x 4	950
Titan	480,000	6.44	40.49	11.06	11.86	10.30	5.67	22.13	19.37	14.57	13.16	2.500	5.68	5/8 x 5-1/8	1825
Jupiter	830,000	7.87	47.29	12.00	12.36	13.94	7.26	24.00	20.40	16.93	13.16	2.500	5.68	5/8 x 5-1/8	2600
Gemini	1,700,000	9.65	53.38	13.98	12.36	18.37	8.67	27.75	20.40	20.47	13.98	2.500	6.50	5/8 x 6	4000
Hercules	2,900,000	11.61	65.75	17.75	20.20	18.96	10.34	35.50	31.25	25.39	14.25	3.000	6.50	3/4 x 5-7/8	6850

World Class Customer Service

For more than 100 years, the dedicated people of Rexnord have delivered excellence in quality and service to our customers around the globe. Rexnord is a trusted name when it comes to providing skillfully engineered products that improve productivity and efficiency for industrial applications worldwide. We are committed to exceeding customer expectations in every area of our business: product design, application engineering, operations, and customer service.

Because of our customer focus, we are able to thoroughly understand the needs of your business and have the resources available to work closely with you to reduce maintenance costs, eliminate redundant inventories and prevent equipment down time.

Rexnord represents the most comprehensive portfolio of power transmission and conveying components in the world with the brands you know and trust.

Rexnord is a registered trademark of Rexnord Industries, LLC.
Falk and Planetgear are trademarks of Rexnord industries, LLC.

WORLDWIDE CUSTOMER SERVICE

AUSTRALIA

Rexnord Australia Pty. Ltd.
Picton, New South Wales
Phone: 61-2-4677-3811
Fax: 61-2-4677-3812

Falk-Rexnord Australia Pty Ltd
Broadmeadow New South Wales
Phone: 61-2-4962-8000
Fax: 61-2-4962-8001

BRAZIL

Rexnord Correntes Ltda.
Sao Leopoldo - RS
Phone: 55-51-579-8022
Fax: 55-51-579-8029

CANADA

Rexnord Canada Ltd.
Scarborough, Ontario
Phone: 1-416-297-6868
Fax: 1-416-297-6873

CHINA

Rexnord China
Shanghai, China
Phone: 86-21-62701942
Fax: 86-21-62701943

EUROPE

Rexnord NV/SA
Mechelen, Belgium
Phone: 32-15-443881
Fax: 32-15-443860

LATIN AMERICA

Rexnord International
Milwaukee, Wisconsin
Phone: 1-414-643-2366
Fax: 1-414-643-3222
E-mail: international1@rexnord.com

MEXICO

Rexnord S. A. de C. V.
Mexico DF, Mexico
Phone: 52-55-9140-3500
Fax: 52-55-9140-3550

SINGAPORE

Rexnord International, Inc.
Singapore City, Singapore
Phone: 65-6338-5622
Fax: 65-6338-5422

UNITED STATES

Customer Service
Phone: 866-Rexnord
(866-739-6673)
E-mail: rexnordcs(state)@rexnord.com
Example: rexnordcsohio@rexnord.com

ALL COUNTRIES NOT LISTED ABOVE

Rexnord International
Milwaukee, Wisconsin
Phone: 1-414-643-2366
Fax: 1-414-643-3222
E-mail: international2@rexnord.com

