



**Falk® Ultramite®**  
**Types UCBN & UCFN • Sizes 201 thru 14**  
**Installation & Maintenance Instructions**

**Motion Control Solutions**  
**Regal Rexnord**  
 111 W. Michigan Street  
 Milwaukee, WI 53203  
 Application Engineering: 800 626 2093  
[regalrexnord.com](http://regalrexnord.com)

**FORM**  
**288-100E**  
**Revised**  
**June 2022**

**⚠ WARNING** indicates a hazard which, if not avoided, could result in serious injury or death.

**⚠ CAUTION** indicates a hazard which, if not avoided, could result in minor or moderate personal injury.

**NOTICE** indicates information considered important, but not hazard-related (e.g. messages relating to property damage).

**How to Use This Manual**

This manual provides detailed instructions on installation and maintenance of gear drives and couplings. Use the table of contents below to locate required information.

**NOTICE:** Carefully follow the instructions in this manual for optimum performance and trouble free service.

**Table of Contents**

Installation Instructions.....Page 1  
 Mounting Positions .....Page 2  
 Tightening Torques.....Page 2  
 Shaft Connections .....Page 3  
 Lubrication Recommendations.....Page 4  
 Preventive Maintenance .....Page 5  
 Stored and Inactive Gear Drives .....Page 5  
 Lube Qty. for Incline Mtg., Sizes 201 202, & 203.....Page 6  
 Lube Qty. for Incline Mtg., Sizes 204, 205, 206, & 207 .....Page 7  
 Lube Qty. for Incline Mtg., Sizes 208, 09, 10, & 12 .....Page 8

**Introduction**

Credit for long service and dependable operation of a gear drive is often given to the engineers who designed it, or the craftsmen who constructed it, or the sales engineer who recommended the type and size. Ultimate credit belongs to the mechanic on the job who worked to make the foundation rigid and level, who accurately aligned the shafts and carefully installed the accessories, and who made sure that the drive received lubrication at prescribed intervals. The details of this important job are the subject of this manual.

**NAMEPLATE** — Operate Rexnord® Gear Drives only at horsepower, speed and ratio shown on nameplate and in the mounting position for which it was ordered. Before changing any one of these, submit complete nameplate data and new application conditions to the Factory for correct oil level, parts and application approval.

**WARNING!** Consult applicable local and national safety codes for proper guarding of rotating members. Lock out power source and remove all external loads from drive before servicing drive or accessories.

**Warranty**

Regal Rexnord™ Corporation (the "Company") warrants that Ultramite gear drives (I) conform to Company's published specifications, and (II) are free from defects of material for three years from the date of shipment.

Company does not warrant any non-Company branded products or components (manufacturer's warranty applies) or any defects in, damage to, or failure of products caused by: (I) dynamic vibrations imposed by the drive system in which such products are installed unless the nature of such vibrations has been defined and accepted in writing by Company as a condition of operation; (II) failure to provide suitable installation environment; (III) use for purposes other than those for which designed, or other abuse or misuse; (IV) unauthorized attachments, modifications or disassembly, or (V) mishandling during shipping.

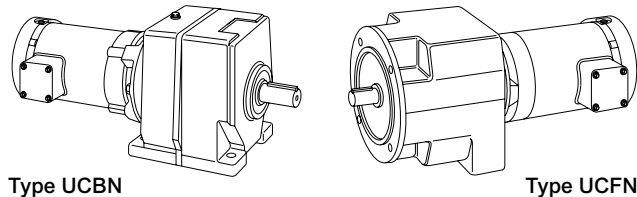

**Installation Instructions**

The following instructions apply to standard Falk Type UCBN (base mounted) and UCFN (flange mounted) drives shown above. If a drive is furnished with special features, refer to the supplementary instructions shipped with the drive.

**WELDING** — Do not weld on the gear drive or accessories without prior approval from the Factory. Welding on the drive may cause distortion of the housing or damage to the bearings and gear teeth. Welding without prior approval could void the warranty.

**EFFECTS OF SOLAR ENERGY** — If the gear drive operates in the sun at ambient temperatures over 100°F(38°C), then special measures should be taken to protect the drive from solar energy. This protection can consist of a canopy over the drive or reflective paint on the drive. If neither is possible, consult the Factory.

**MOUNTING (Figure 1, Page 2)** — Sizes 201 thru 207 are furnished filled with oil to the approximate level determined by the mounting position ordered. Sizes 208 thru 14 are furnished without oil. Refer to **Table 3, Page 4** for a list of typical lubricants meeting Regal Rexnord specifications. Fill drives to the oil level plug. Refer to **Table 4, Page 5** for the approximate quantities of oil by the drive mounting position. Refer to **Figure 1, Page 2** for the placement of the vent, drain and oil level plugs based on the drive mounting position.

**FOUNDATION GENERAL** — To facilitate oil drainage, elevate the gear drive foundation above the surrounding floor level. If desired, replace the drive oil drain plug with a valve, but provide a guard to protect the valve from accidental opening or breakage.

**FOUNDATION, STEEL** — When mounting gear drive on structural steel, it is recommended that an engineered design be utilized for a pedestal, adapter base or bed to provide sufficient rigidity, to prevent induced loads from distorting the housing and causing gear misalignment. In the absence of an engineered design, it is recommended that a base plate, with thickness equal to or greater than the thickness of the drive feet, be securely bolted to steel supports and extend under the entire drive.

**FOUNDATION, CONCRETE** — If a concrete foundation is used, allow the concrete to set firmly before bolting down the gear drive. For the best type of mounting, grout structural steel mounting pads into the mounting base, as illustrated, rather than grouting the drive directly into the concrete.

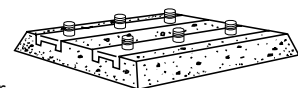

**NOTICE:** Motors and other components mounted on motor plates may become misaligned during shipment. ALWAYS check alignment after installation.

Mounting 1

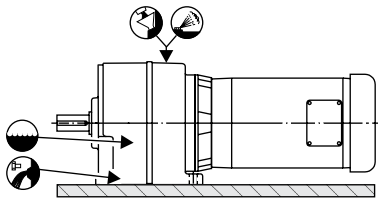

Mounting 4

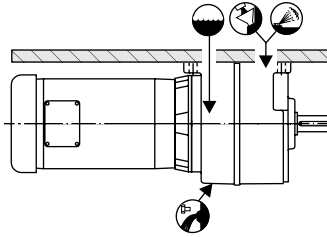

Mounting 5

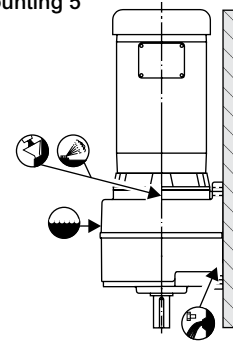

Mounting 3

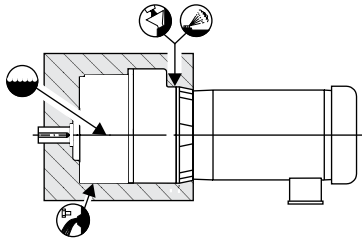

Mounting 2

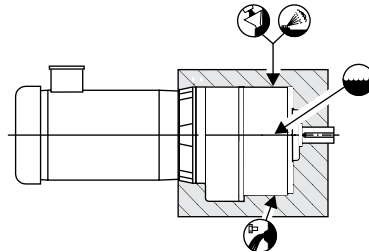

Mounting 6 ‡

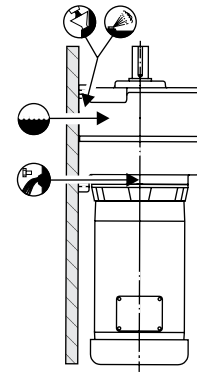

Mounting 7

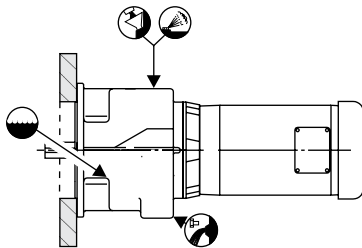

Mounting 8

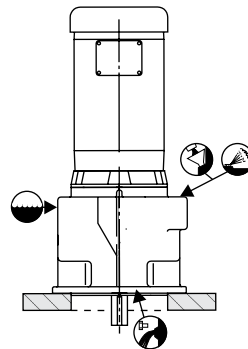

Mounting 9 ‡

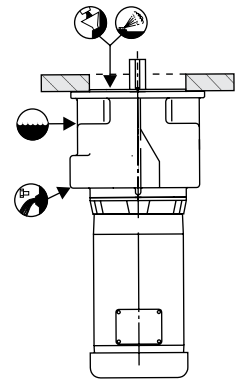

Figure 1



‡ Use motor fitted with a seal.

### Fastener Tightening Torques

Use the tightening torque values specified in **Table 1**, for fastening gear drives, motors, and accessories to their mounting surfaces with non-lubricated fasteners.

**NOTICE:** DO NOT use these values for “torque locking” fasteners or for fastening components with aluminum feet or with soft gaskets or vibration dampers on the mounting surface. If the tightening torque exceeds the capacity of the torque wrench, use a torque multiplier. Use Grade 5 fasteners for diameters through 1.50”.

**TABLE 1 — Tightening Torques (lb-in) ±5%**  
DO NOT Lubricate Fasteners

Thread Dia – UNC	Metal to Metal	Metal to Concrete
.250-20	90	70
.3125-18	185	145
.375-16	330	255
.500-13	825	640
.625-11	1640	1280
.750-10	2940	2290



**GEAR DRIVE ALIGNMENT** — Align drive with driven equipment by placing broad, flat shims under all mounting pads. Start at the low speed shaft end and level across the length and then the width of the drive. Check with a feeler gauge to make certain that all pads are supported to prevent distortion of housing when drive is bolted down. After drive is aligned with driven equipment and bolted down, align prime mover to drive input shaft. Refer to next column for coupling alignment.

Check high speed shaft coupling alignment. If the coupling is misaligned, the drive is shimmed incorrectly. Re-shim drive and recheck high speed coupling alignment. If necessary, realign motor.

### Shaft Connections

**WARNING!** Provide suitable guards in accordance with OSHA standards.

Input and output shaft extension diameter tolerance is +.0000"; -.0005" for shafts up to 1.375" diameter and +.000"; -.001" for shafts larger than 1.375" diameter. The fitted component must be machined to ensure proper fit.

**NOTICE:** DO NOT drive coupling hub, pinion, sprocket or pulley on the shaft. An endwise blow on the shaft may damage gears and bearings. Coupling hubs, pinions, sprockets or pulleys must be pushed onto the shaft using a screw jack device fitted into the threaded hole provided in the end of the shaft, see **Table 2** below.

**TABLE 2 — Shaft End threaded Holes – Inches**

DRIVE SIZE	Input Shaft	Output Shaft
201	.250 x .500 UNF	.250 x .630 UNF
202	.250 x .500 UNF	.250 x .710 UNF
203	.250 x .500 UNF	.250 x .710 UNF
204	.250 x .630 UNF	.375 x .750 UNF
205	.250 x .630 UNF	.375 x .750 UNF
206	.250 x .630 UNF	.375 x .750 UNF
207	.312 x .630 UNF	.750 x 1.50 UNF
208	.312 x .870 UNF	.625 x 1.42 UNF
09	.500 x 1.10 UNF	.750 x 1.65 UNF
10	.625 x 1.42 UNF	.750 x 1.65 UNF
12	.750 x 1.65 UNF	1.00 x 1.97 UNF

**COUPLING CONNECTIONS** — The performance and life of any coupling depends largely upon how well the coupling is installed and serviced. Refer to the coupling manufacturer's manual for specific instructions.

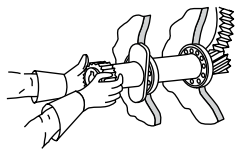

#### CORRECT METHOD

Heat interference fitted coupling hubs, pinions, sprockets or pulleys to a maximum of 275°F (135°C) and slide onto gear drive shaft.

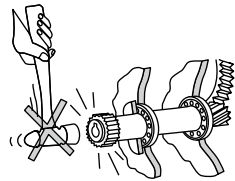

#### INCORRECT METHOD

DO NOT drive coupling hub, pinion, sprocket or pulley onto the shaft. An endwise blow on the shaft/coupling may damage gears and bearings.

**NOTICE:** DO NOT HAMMER

**FALK® COUPLINGS** — (Except fluid type) Detailed installation manuals are available from the Factory, your local Regal Rexnord™ Representative or Distributor — just provide size and type designations stamped on the coupling. For lubricant requirements and a list of typical lubricants meeting Regal Rexnord specifications, refer to appropriate coupling service manual.

**GAP AND ANGULAR ALIGNMENT** — If possible, after mounting coupling hubs, position the driving and driven equipment so that the distance between shaft ends is equal to the coupling gap. Align the shafts by placing a spacer block, equal in thickness to required gap, between hub faces, as shown, and also at 90° intervals around the hub. Check with feelers.

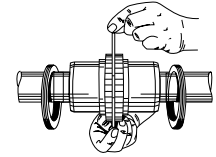

Steelflex Illustrated

**OFFSET ALIGNMENT** — Align driving and driven shafts so that a straight edge will rest squarely on both couplings hubs as shown to the right and also at 90° intervals. Tighten foundation bolts of the connected equipment and recheck alignment and gap.

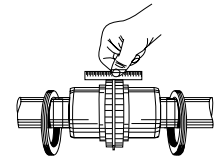

Steelflex® Illustrated

**SPROCKETS, PULLEYS OR SHEAVES** — Mount power take-offs as close to the gear drive housing as possible to avoid undue bearing load and shaft deflection.

Align the output shaft of the gear drive square and parallel with the driven shaft by placing a straightedge across the face of the sprockets or sheaves as illustrated. Check horizontal shaft alignment by placing one leg of a square against the face of the sheave or sprocket with the spirit level on the horizontal leg of the square.

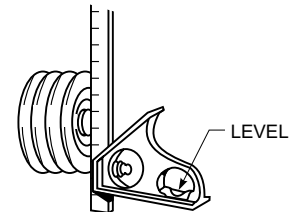
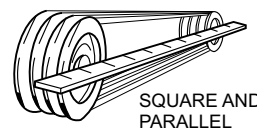
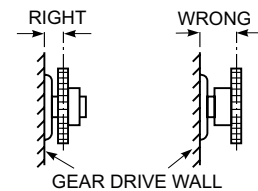

**NOTICE:** DO NOT over tighten belts or chains. Adjust chains to manufacturers' specifications. Adjust belts as follows:

The ideal tension is the lowest tension at which the belt will not slip under peak load conditions. Check the belt tension frequently during the first 24 to 48 hours of run-in operation. Over tightening belts shortens belt and bearing life. Keep belts free from foreign material which may cause slippage. Inspect the V-belts periodically; tighten the belts if they are slipping.

**PINION MOUNTING** — Mount pinion as close to the drive as possible to avoid undue bearing load and shaft deflection. Refer to the Factory for pinion alignment instructions.

**FALK**

## Lubrication Recommendations

Carefully follow lubrication instructions on warning tags and installation manuals furnished with the gear drive. Nameplates are stamped with a designation for recommended lubricant, standard is 6E.

Lubricants listed in this manual are typical ONLY and should not be construed as exclusive recommendations. Refer to your lubricant supplier for additional lubricants meeting the indicated specifications. Industrial type extreme pressure (EP) gear lubricants are the recommended lubricants for ambient temperatures of 15°F to 125°F (-9°C to +52°C).

For drives operating outside the above temperature range refer to “Synthetic Lubricants” paragraphs. Synthetic lubricants can also be used in normal climates.

**VISCOSITY (IMPORTANT)** — The proper grades of EP Mineral lubricants and EP Synthetic lubricants are found in **Table 3**. For cold climates refer to “EP Synthetic Lubricant” paragraphs. Select a lubricant which has a pour point at least 10°F (5.5°C) below the expected minimum ambient starting temperature. Usable temperature ranges can sometimes be widened if specific application conditions are known.

**TABLE 3 — Typical Lubricants Recommendations & Specifications**

Mineral Lubricants Extreme Pressure		AGMA Viscosity Grade				
		...	...	5EP	6EP	7EP
		ISO Viscosity Grade				
		...	...	220	320	460
		Nameplate Designation				
		...	...	5E	6E	7E
		Ambient Temperature Range °F				
Manufacturer	Lubricant	...	...	+23 to +77	+32 to +104	+50 to +122
Chevron* USA Inc.	Gear Compounds EP	...	...	220	320	460
Exxon* Co. USA	Spartan* EP	...	...	220	320	460
Mobil* Oil Corp.	Mobilgear*	...	...	630	632	634
Shell* Oil Co.	Omala* Oil	...	...	220	320	460

Synthetic Lubricants ‡ Extreme Pressure (Except where noted) †		AGMA Viscosity Grade				
		0S	2S	5S	6S	7S
		ISO Viscosity Grade				
		32	68	220	320	460
		Nameplate Designation				
		0H	2H	5H	6H	7H
		Ambient Temperature Range °F				
Manufacturer	Lubricant	-30 to +10	-15 to +50	+14 to +86	+32 to 113	+50 to +122
Conoco* Inc.	Syncon*	32 †	68	220	...	...
Exxon Co. USA	Spartan Synthetic EP	...	...	220	320	460
Mobil Oil Corp.	Mobilgear SHC	...	...	220	320	460
	Mobil SHC	624 †	626 †	...	...	...
Pennzoil* Prod. Co.	Super Maxol "S"	...	68	220	320	460
Shell Oil Co.	Hyperia S	...	...	220	...	460
Sun Company* Inc.	Sunoco* Challenge EP	...	...	220	320	...
	Sunoco Challenge AC	32 †	68 †	...	...	...

‡ Consult lubricant supplier/manufacturer for maximum operating temperature.

† Lubricant does not contain EP (extreme pressure) additives. Consult your lubricant supplier for additional lubricant recommendations.

\* The following trademarks or trade names are of a third party and not owned by or under the control of Regal Rexnord™ Corporation.

## Extreme Pressure (EP) Mineral Lubricants

**Mineral (EP) Lubricants (Table 3)** — Industrial type petroleum based extreme pressure lubricants are preferred. The EP lubricants currently recommended are of the sulfur-phosphorus type.

**WARNING! EP LUBRICANTS IN FOOD PROCESSING INDUSTRY** — EP lubricants may contain toxic substances and should not be used in the food processing industry without the lubricant manufacturers' approval. Lubricants which meet USDA "H1" classification are suitable for food processing applications.

## Extreme Pressure (EP) Synthetic Lubricants

**Synthetic (EP) Lubricants (Table 3)** — Polyalphaolefin type extreme pressure lubricants are recommended for cold climate operation, high temperature applications, extended temperature range (all season) operation and/or extended lubricant change intervals.

**WARNING! SYNTHETIC LUBRICANTS IN FOOD PROCESSING INDUSTRY** — Synthetic lubricants may contain toxic substances and should not be used in the food processing industry without the lubricant manufacturers' approval. Lubricants which meet USDA "H1" classification are suitable for food processing applications.

## Oil Levels

**Sizes 201 thru 207** are furnished filled with oil determined by the drive mounting position ordered and require no further lubrication. For inclined mounting, see **Pages 6 & 7** for lubricant quantities.

**Sizes 208 thru 12** are furnished without lubricant. Oil levels are determined by drive mounting position. For inclined mounting, see **Page 8** for lubricant quantities.

Location of the vent, drain and oil level plugs are determined by the drive mounting position and are shown in **Figure 1, Page 2**. Refer to **Table 4, Page 5** for approximate quantities of oil by drive mounting position.

## Lubricant Changes

**OIL ANALYSIS REPORT** — Checking oil condition at regular intervals is recommended. In the absence of more specific limits, the guidelines listed below may be used to indicate when to change oil:

1. Water content is greater than 0.05% (500 ppm).
2. Iron content exceeds 150 ppm.
3. Silicon (dust/dirt) exceeds 25 ppm.
4. Viscosity changes more than 15%.

The UC Ultramite® can require an oil change at 2,500 hours for EP mineral lubricants and 10,000 for polyalphaolefin type EP synthetic lubricants.



## Preventive Maintenance

**AFTER FIRST WEEK** — Check alignment of the total system and realign where necessary. Also, tighten all external bolts and plugs where necessary.

**NOTICE:** DO NOT readjust the internal gear or bearing settings in the drive, these were permanently set at the factory.

**PERIODICALLY** — **Sizes 204 thru 12** Carefully check the oil level of the drive when it is stopped and at ambient temperature, add oil if needed. If the oil level is ABOVE the oil level plug have the oil analyzed for water content. If moisture content exceeds 500 ppm change the oil.

**NOTICE:** DO NOT fill above the oil level plug as leakage or undue heating may result. Also check coupling alignment to make certain that foundation settling has not caused excessive misalignment.

## Stored & Inactive Gear Drives

Each gear drive is protected with rust preventive that will protect parts against rust for a period of 6 months in an indoor dry shelter.

**Sizes 204 thru 12** — If a gear drive is to be stored, or is inactive after installation beyond the above periods, drain oil from housing and spray all internal parts with a rust preventive oil that is soluble in lubricating oil or add “Motorstor”<sup>™</sup> vapor phase rust inhibitor at the rate of one ounce per cubic foot of internal drive space (or 5% of sump capacity) and rotate the shafts several times by hand. Before operating, drives which have been stored or inactive must be filled to the proper level with oil meeting the specifications given in this manual. Refer to **Manual 128-014** for “Start-up after Storage” instructions.

**Notice:** Periodically inspect stored or inactive gear drives and spray or add rust inhibitor every six months, or more often if necessary. Indoor dry storage is recommended.

Gear drives ordered for extended storage can be treated at the factory with a special preservative and sealed to rust-proof parts for periods longer than those cited previously.

## Material Safety Data

Drives with nameplate designation 6E are filled with Mobilgear<sup>®</sup> 632, drives with nameplate designation 6H are filled with Mobilgear SHC 320. Material safety data sheets for these products can available directly from Mobil<sup>®</sup> Oil Corporation at:

Products & Technology Department  
3225 Gallows Road  
Fairfax, VA 22037  
Phone: (800) 662-4525 or  
Phone: (703) 849-3265

For material safety data sheets pertaining to other products used in the manufacture of the Falk<sup>®</sup> Ultramite<sup>®</sup> contact:

Regal Rexnord<sup>™</sup> Corporation  
Customer Service Department  
3001 W. Canal Street  
Milwaukee, WI 53208-4200  
Phone: (414) 342-3131

**TABLE 4 — Approximate Oil Quantities – Liters †**

Mtg Position	DRIVE SIZE																					
	Double Reduction										Triple Reduction											
	201UC	202UC	203UC	204UC	205UC	206UC	207UC	208UC	09UC	10UC	12UC	201UC	202UC	203UC	204UC	205UC	206UC	207UC	208UC	09UC	10UC	
<b>1</b>	.7	.8	.8	1.5	1.5	2.0	2.6	3.7	10.5	11.0	17.0	.7	.8	.8	1.3	1.3	1.9	2.3	3.4	11.5	11.0	
<b>2</b>	.7	.8	.8	1.8	1.8	2.0	3.1	6.2	12.7	22.0	31.0	.7	.8	.8	1.6	1.6	1.8	2.9	6.0	12.7	23.0	
<b>3</b>	.7	.8	.8	1.6	1.6	1.8	2.8	5.4	12.7	22.0	31.0	.7	.8	.8	1.5	1.5	1.7	2.6	5.8	12.7	23.0	
<b>4</b>	.7	.8	.8	1.9	1.9	2.1	3.3	7.3	12.7	19.0	28.0	.7	.8	.8	1.9	1.9	2.1	3.3	7.9	12.7	20.0	
<b>5</b>	1.0	1.5	1.5	1.9	1.9	2.1	3.2	6.4	17.5	32.0	47.0	1.0	1.5	1.5	1.9	1.9	1.9	2.9	6.4	17.5	32.0	
<b>6</b>	1.0	1.5	1.5	2.7	2.7	2.9	4.9	9.1	17.2	26.0	38.0	1.0	1.5	1.5	2.5	2.5	2.7	4.7	9.3	17.2	27.0	
<b>7</b>	.7	.8	.8	1.5	1.5	2.0	2.6	3.7	10.5	11.0	17.0	.7	.8	.8	1.3	1.3	1.9	2.3	3.4	11.5	11.0	
<b>8</b>	1.0	1.5	1.5	1.9	1.9	2.1	3.2	6.4	16.0	22.0	45.0	1.0	1.5	1.5	1.9	1.9	1.9	2.9	6.4	16.0	22.0	
<b>9</b>	1.0	1.5	1.5	2.7	2.7	2.9	4.9	9.1	17.0	28.0	43.0	1.0	1.5	1.5	2.5	2.5	2.7	4.7	9.3	19.0	29.0	
<b>Compound Stage Quadruple Reduction (Quantities obtained from above double reduction sizes)</b>																						
DRIVE SIZE		203UC4	204UC4	205UC4	206UC4	207UC4	208UC4	09UC4	10UC4	12UC4												
Primary Drive Assembly 7, 8, or 9		201UC2	203UC2	203UC2	203UC2	203UC2	203UC2	205UC2	205UC2	207UC2	207UC2											
Secondary Drive Assembly 1 thru 6		203UC2	204UC2	205UC2	206UC2	207UC2	208UC2	09UC2	10UC2	12UC2												
<b>Compound Stage Quintuple Reduction (Quantities obtained from above double and triple reduction sizes)</b>																						
DRIVE SIZE		203UC5	204UC5	205UC5	206UC5	207UC5	208UC5	09UC5	10UC5	12UC5												
Primary Drive Assembly 7, 8, or 9		201UC3	203UC3	203UC3	203UC3	203UC3	203UC3	205UC3	205UC3	207UC3	207UC3											
Secondary Drive Assembly 1 thru 6		203UC2	204UC2	205UC2	206UC2	207UC2	208UC2	09UC2	10UC2	12UC2												

† Convert quantities using the following: Liters to US Gallons = liters x 0.26, Liters to Imperial Gallons = liters x 0.22, Liters to US Quarts = liters x 1.057.

\* The following trademarks or trade names are of a third party and not owned by or under the control of Regal Rexnord Corporation.



# LUBRICANT QUANTITIES FOR INCLINED MOUNTING SIZES 201, 202, & 203

For inclinations within  $\pm 5^\circ$ , use standard lubricant quantity as shown in Table 4 on Page 5.

For inclinations above  $5^\circ$ , use lubricant quantity (liters) as shown in Tables 5 & 6 below.

## SHAFT INCLINED

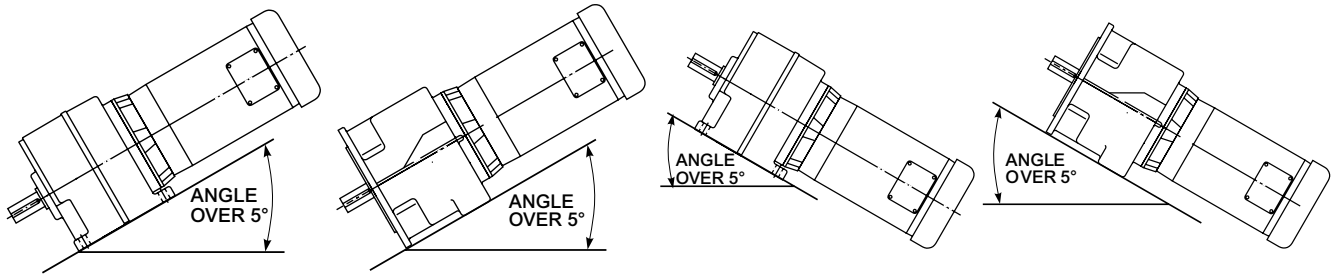
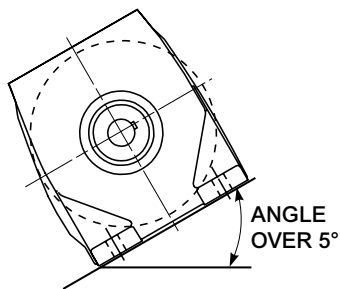

**TABLE 5 — Approximate Oil Quantities – Liters †**

Shaft Inclined Above $5^\circ$	Drive Type	DRIVE SIZE			
		201UC2	201UC3	202/203UC2	202/203UC3
Down	Base Mount	0.9	1.8	1.7	2.5
	Flange Mount	0.9	1.8	1.6	2.3
Up	Base Mount	1.1	1.6	1.9	2.5
	Flange Mount	1.1	1.6	1.8	2.3

† Convert quantities using the following: Liters to US Gallons = liters x 0.26, Liters to Imperial Gallons = liters x 0.22, Liters to US Quarts = liters x 1.057.

## ELEVATION INCLINED



**TABLE 6 — Approximate Oil Quantities – Liters †**

Drive Type	DRIVE SIZE			
	201UC2	201UC3	202/203UC2	202/203UC3
Base Mount	0.9	1.1	1.3	1.7
Flange Mount	0.9	1.1	1.3	1.7

† Convert quantities using the following: Liters to US Gallons = liters x 0.26, Liters to Imperial Gallons = liters x 0.22, Liters to US Quarts = liters x 1.057.

# LUBRICANT LEVELS & QUANTITIES FOR INCLINED MOUNTING SIZES 204, 205, 206, & 207

For inclined drives, it is important to fill to the correct oil level plug as shown below.

Note: Follow instructions for the drive at the correct inclination.

## ELEVATION INCLINED

Oil quantities will vary depending on the angle of incline and ratio. Maximum oil quantity (liters) as shown in **Table 7 & 8** below.

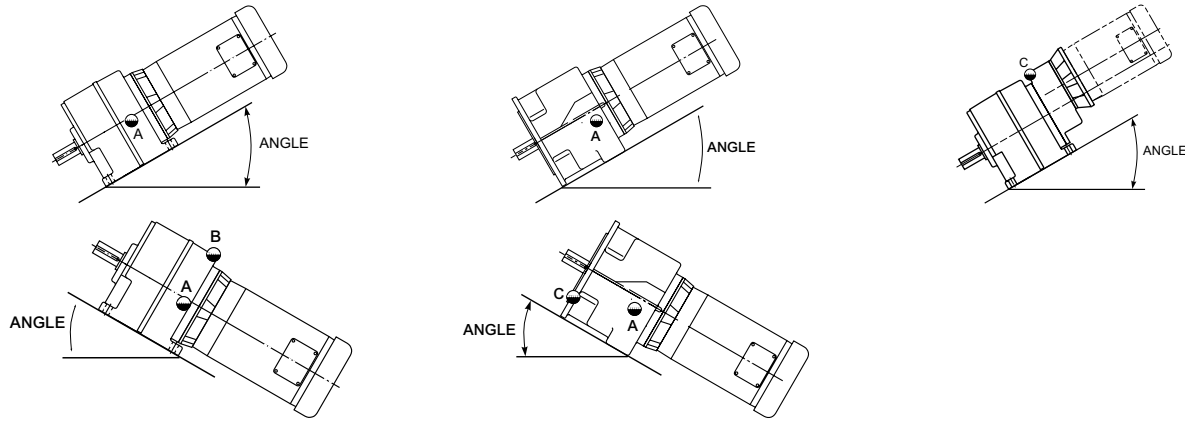
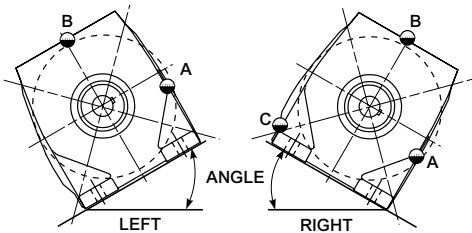

**TABLE 7 — Approximate Oil Quantities & Plug Positions – Liters †**

Shaft Down		DRIVE SIZE											
		204/205UC2		204/205UC3		206UC2		206UC3		207UC2		207UC3	
Degrees of Incline	Drive Type	Quantity	Plug Position	Quantity	Plug Position	Quantity	Plug Position	Quantity	Plug Position	Quantity	Plug Position	Quantity	Plug Position
All	Base Mount	3.4	A	4.2	C	4.1	A	5.3	C	5.0	A	7.8	C
	Flange Mount	2.9	A	4.2	C	4.0	A	5.5	C	4.8	A	8.1	C
Shaft Up		204/205UC2		204/205UC3		206UC2		206UC3		207UC2		207UC3	
Degrees of Incline	Drive Type	Quantity	Plug Position	Quantity	Plug Position	Quantity	Plug Position	Quantity	Plug Position	Quantity	Plug Position	Quantity	Plug Position
0° - 30°	Base Mount	1.8	A	1.9	A	1.8	A	1.9	A	2.8	A	2.1	A
	Flange Mount	1.8	A	1.9	A	2.1	A	2.1	A	3.0	A	3.0	A
31° - 60°	Base Mount	3.1	B	4.2	B	4.1	B	5.3	B	5.0	B	7.8	B
	Flange Mount	3.3	C	4.2	C	4.3	C	5.3	C	5.4	C	7.8	C

† Convert quantities using the following: Liters to US Gallons = liters x 0.26, Liters to Imperial Gallons = liters x 0.22, Liters to US Quarts = liters x 1.057.

## SHAFT INCLINED



**TABLE 8 — Approximate Oil Quantities & Plug Positions – Liters †**

Degrees of Incline	Drive Type	DRIVE SIZE											
		204/205UC2		204/205UC3		206UC2		206UC3		207UC2		207UC3	
		Quantity	Plug Position	Quantity	Plug Position	Quantity	Plug Position	Quantity	Plug Position	Quantity	Plug Position	Quantity	Plug Position
0° - 50° Left	Base Mount	4.6	A	4.2	A	4.1	A	5.4	A	5.1	A	7.9	A
51° - 90° Left		3.2	B	4.2	B	4.1	B	5.4	B	5.1	B	7.9	B
0° - 20° Right		1.6	A	1.6	A	1.8	A	2.0	A	2.4	A	2.8	A
21° - 65° Right		3.2	C	4.2	C	4.1	C	5.4	C	5.1	C	7.9	C
66° - 90° Right		3.2	B	4.2	B	4.1	B	5.4	B	5.1	B	7.9	B

† Convert quantities using the following: Liters to US Gallons = liters x 0.26, Liters to Imperial Gallons = liters x 0.22, Liters to US Quarts = liters x 1.057.

# LUBRICANT LEVELS & QUANTITIES FOR INCLINED MOUNTING SIZES 208, 09, 10. For Size 12, Contact the Factory

For inclined drives, it is important to fill to the correct oil level plug as shown below.

Note: Follow instructions for the drive at the correct inclination.

## ELEVATION INCLINED

Oil quantities will vary depending on the angle of incline and ratio. Maximum oil quantity (liters) as shown in **Table 9 & 10** below.

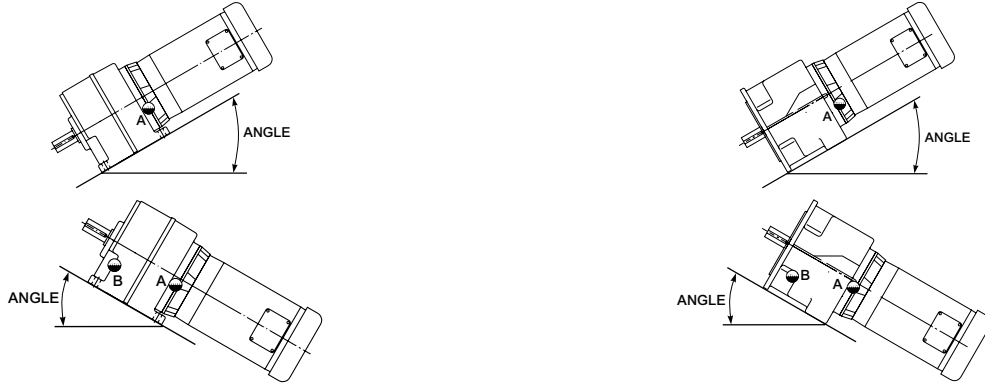
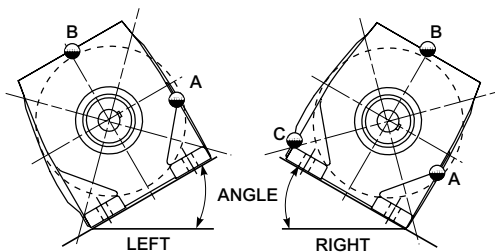

**TABLE 9 — Approximate Oil Quantities & Plug Positions – Liters †**

Shaft Down		DRIVE SIZE					
		208UC2/3		09UC2/3		10UC2/3	
Degrees of Incline	Drive Type	Quantity	Plug Position	Quantity	Plug Position	Quantity	Plug Position
0° - 70°	Base Mount	8.6	A	17.5	A	26	A
	Flange Mount	7.9	A	16.0	A	22	A
Shaft Up		208UC2/3		09UC2/3		10UC2/3	
Degrees of Incline	Drive Type	Quantity	Plug Position	Quantity	Plug Position	Quantity	Plug Position
0° - 20°	Base Mount	5.9	A	13	A	20	A
	Flange Mount	6.2	A	12.5	A	19	A
21° - 90°	Base Mount	8.3	B	17	B	27	B
	Flange Mount	8.6	B	19	B	29	B

† Convert quantities using the following: Liters to US Gallons = liters x 0.26, Liters to Imperial Gallons = liters x 0.22, Liters to US Quarts = liters x 1.057.

## SHAFT INCLINED



**TABLE 10 — Approximate Oil Quantities & Plug Positions – Liters †**

Degrees of Incline	Drive Type	DRIVE SIZE					
		208UC2/3		09UC2/3		10UC2/3	
		Quantity	Plug Position	Quantity	Plug Position	Quantity	Plug Position
0° - 50° Left	Base Mount	10.2	A	19	A	27	A
51° - 90° Left		10.2	B	19	B	27	B
0° - 20° Right		3.6	A	7.0	A	10	A
21° - 65° Right		9.3	C	18	C	26	C
66° - 90° Right		9.3	B	18	B	26	B

† Convert quantities using the following: Liters to US Gallons = liters x 0.26, Liters to Imperial Gallons = liters x 0.22, Liters to US Quarts = liters x 1.057.